



PERFORMANCE &  
SMOOTH FINISH

## Core Flue System

The performance twin wall system  
for multifuel stoves.

**SCHIEDEL**

# Product description

## CORE TWIN WALL PRODUCT FEATURES

Introducing Schiedel Core Twin Wall, the advanced double-wall system that is designed with installers in mind.

The simple push-fit connection gives a smooth finish, with limited ridges to make the chimney system aesthetically pleasing.

Core Twin Wall features a distinctive rockwool insulation that maintains its properties even under extreme temperatures, reaching up to 1200°C.

Core Twin Wall's thermal expansion capability of up to 18mm ensures that it retains its structural integrity.

The Core Twin Wall range includes all the required accessory components for standard installations both internally and externally.

- **EASY INSTALLATION - DESIGNED WITH THE INSTALLER IN MIND.**  
Simple push fit design with easy locking mechanism.
- **CLEAN AND SMOOTH APPEARANCE - LOCKING BANDS GIVE A SMOOTH FINISH.**  
Smooth design, with limited ridges.
- **MATT BLACK FINISH THROUGHOUT THE INSTALLATION.**  
Excellent finish to match most appliances.
- **HIGH TEMPERATURE RATED.**  
Suitable for low and high kW stove systems.
- **CHIMNEY CONTINUOUSLY INSULATED.**  
Safe from bottom to top, with excellent insulation and low distance to combustible.
- **NO THERMAL BRIDGING OR HOT SPOTS.**  
High quality manufacturing process and completely safe.
- **MULTIFUEL.**  
Wood, solid fuel, gas and oil can be used.



# Technical data

PROPERTY	TECHNICAL DATA
Fuel type	Wood, solid fuel, gas, oil
Diameter (internal)	100, 130, 150
Diameter (external)	150, 180, 200
Liner thickness (internal)	0.4mm
Insulation thickness per diameter	25mm
Weight per diameter (kg/m)	5.8 kg /m - 8.4 kg/m
Outer case thickness	0.5mm
Flue gas temp (dry)	≤ 450°C
Liner material:	High grade 316 stainless steel
Outer case finish:	304 stainless steel - painted black (RAL 9005)
Insulation type:	High density, rockwool insulation
Thermal expansion	18mm
Max. length free standing:	2.0 m above the last support
Max. support spacing (lateral support)	3.0 m
Average thermal resistance (200°C)	0.37m <sup>2</sup> k/W

## CORROSION RESISTANCE

Chimneys are subject to significant corrosion attack by flue gas condensates. Core Twin Wall is specifically designed and manufactured from true stainless steel to resist this corrosion.

## CHIMNEY DIAMETER

The chimney size should be as recommended by the appliance manufacturer. Where there is a requirement for a flue diameter smaller than the appliance spigot, then the operational requirements of the appliance and the configuration of the flue must satisfy the flue sizing requirements of EN13384-1 for single appliances.

Core is available in internal diameters of 100mm, 130mm and 150mm. External is 150mm, 180mm and 200mm.

# Approvals

## SYSTEM CHIMNEY

Core Twin Wall is CE certified to EN 1856-1:2009 with designations:

Model	Dimensions	Designation String
Tested fully enclosed in a non-combustible shaft; floor penetration fully ventilated with ventilated fire-stop plates. With unprotected floors.	DN (100 – 150)	T450 N1 W V2 L50050 G60 (Painted)
		T450 N1 D V3 L50050 G60 (Painted)
Tested fully enclosed in a non-combustible shaft; floor penetration fully ventilated with ventilated fire-stop plates. With protected floors - 10mm non-combustible boarding.	DN (100 – 150)	T450 N1 W V2 L50050 G50 (Painted)
		T450 N1 D V3 L50050 G50 (Painted)

## CERTIFICATIONS & STANDARDS



# Typical installation

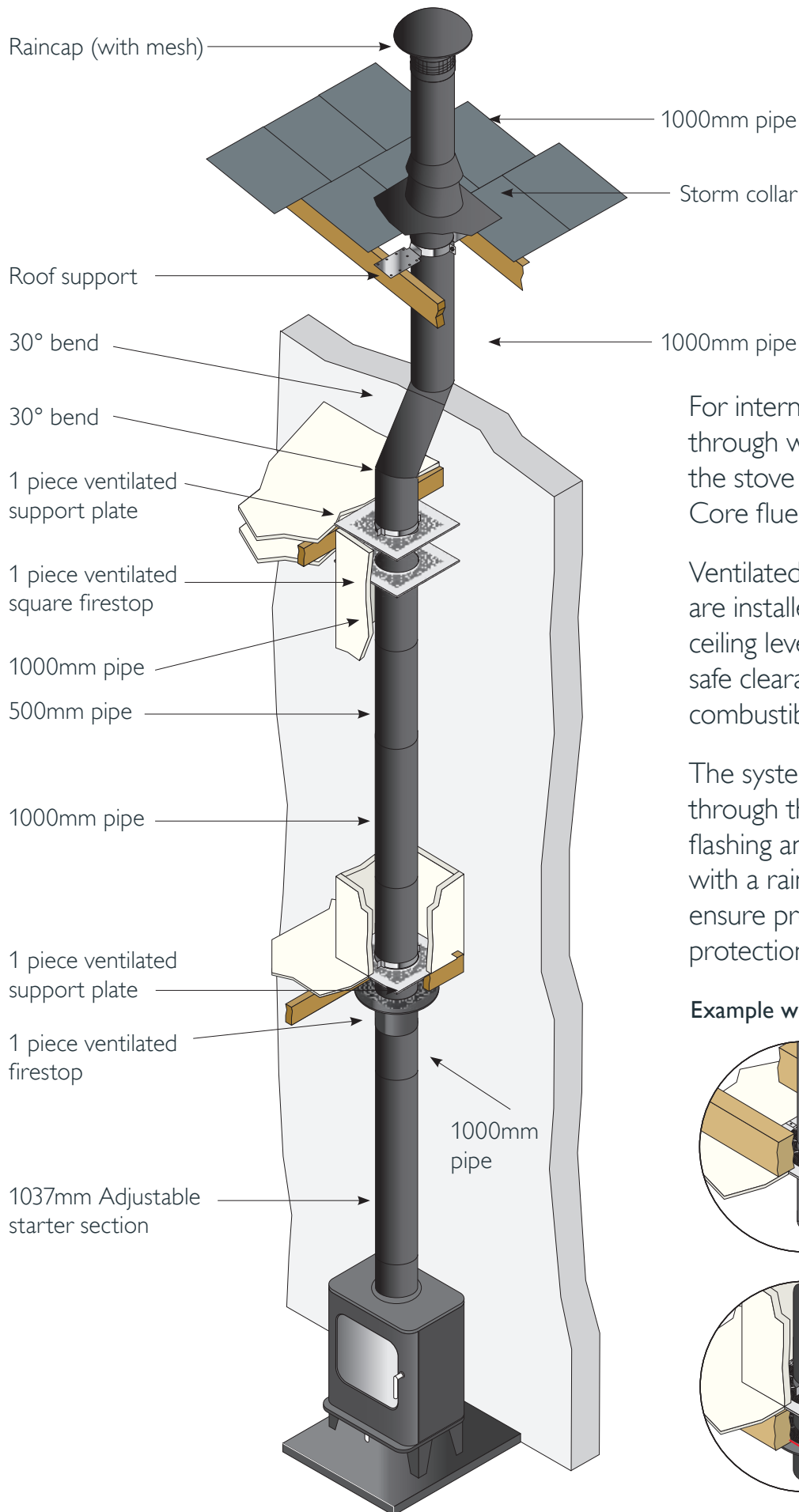

For internal routing through wood joist floors, the stove connects to a Core flue.

Ventilated firestop plates are installed at each ceiling level to maintain safe clearances from combustible materials.

The system passes through the roof using flashing and terminates with a rain cap to ensure proper draw and protection.

## Example with G60 firestop plates

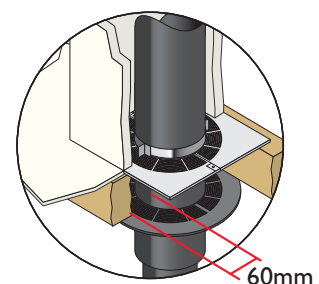
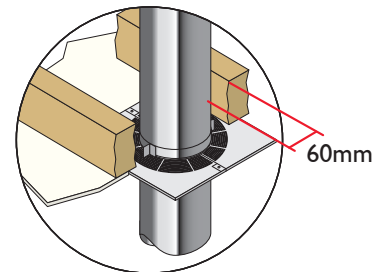

# Typical installation

For homes without masonry chimneys, the stove connects to a Core pipe passing through an insulated wall sleeve.

Outside, a 135° Tee with cleaning access anchors the vertical flue.

Secured by brackets, the chimney rises to the roofline, ending with a rain cap to ensure proper draw and weather protection.

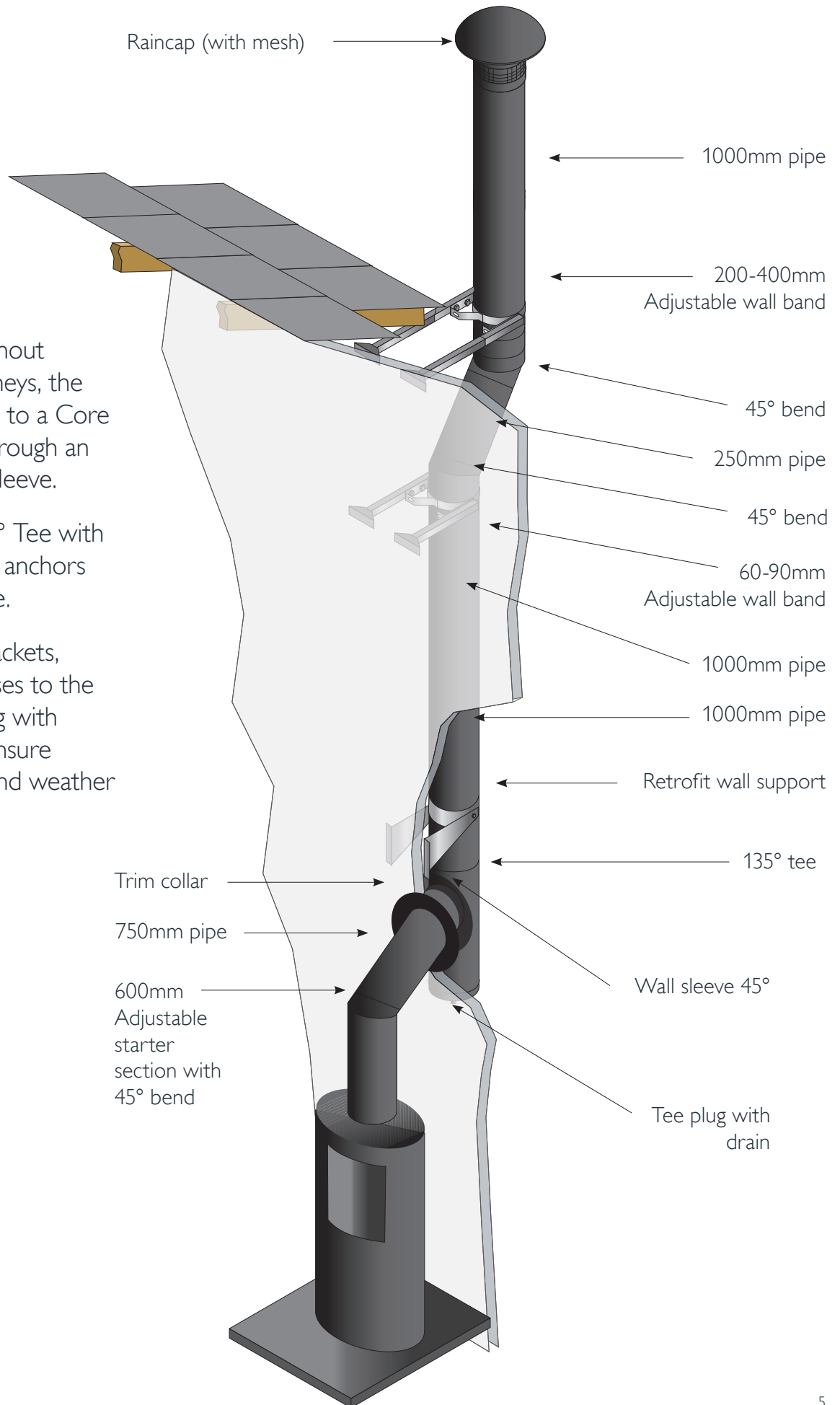

# Starting components

Starting components serve as the interface between the stove and the main chimney system. These parts, such as adapters and increasing sections, securely transition the appliance's outlet to the insulated flue pipe. Designed to withstand high initial temperatures, they ensure a tight seal and provide for a safe and efficient draught.



## Adjustable starter section 600mm with test point

SAP code	180301	180302	180303
Int Ømm	100	130	150
Ext Ømm	150	180	200



## Adjustable starter section 1037mm with test point

SAP code	180298	180299	180300
Int Ømm	100	130	150
Ext Ømm	150	180	200

## FEATURED PRODUCT

This new 600mm adjustable starter section is engineered with a 45° bend to reduce the additional fitting work needed for external installs.

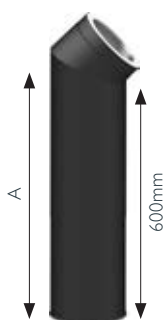

## 600mm adjustable starter section with 45° bend and test point

SAP code	180304	180305
Int Ømm	130	150
Ext Ømm	180	200
A	690	700

With test point

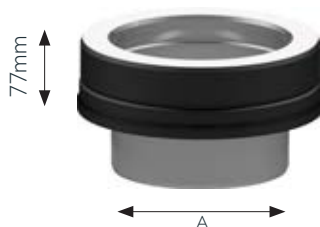

## Insulated appliance connector

SAP code	180262	180263	180264
Int Ømm	100	130	150
Ext Ømm	150	180	200
A	97	123	147

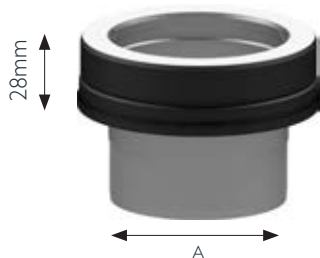

## Prima Smooth to Core adaptor

SAP code	180267	180268
Int Ømm	130	150
Ext Ømm	180	200
A	129.6	149.6

# Starting components

Starting components serve as the interface between the stove and the main chimney system. These parts, such as adapters and increasing sections, securely transition the appliance's outlet to the insulated flue pipe. Designed to withstand high initial temperatures, they ensure a tight seal and provide for a safe and efficient draught.

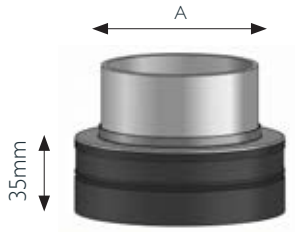

## Core to Prima Smooth adaptor

SAP code	180269	180273
Int Ømm	130	150
Ext Ømm	180	200
A	129.6	149.6

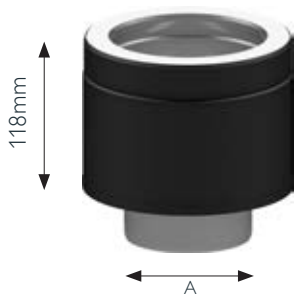

## Increasing insulated appliance connector

SAP code	180265	180266
Int Ømm	130	150
Ext Ømm	180	200
A	97	123

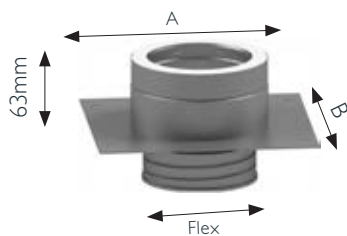

## Anchor plate (screwtype)

SAP code	180295	180296	180297
Int Ømm	100	130	150
Ext Ømm	150	180	200
A	250	280	300
B	270	300	320
Ø Flex	100	125	155

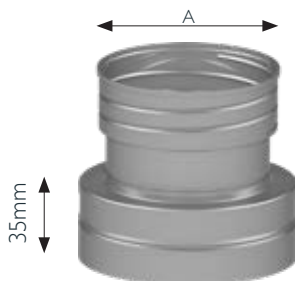

## Adaptor to Flex (screwtype)

SAP code	180270	180271	180272
Int Ømm	100	130	150
Ext Ømm	150	180	200
A	100	125	155

# Pipe lengths

Pipe lengths act as the primary building blocks of the chimney system, offered in various fixed and adjustable sizes to accommodate exact installation heights. These Core sections push fit connect using a secure locking band, ensuring continuous insulation and a flue gas tight seal along the entire run. Supplied with locking band.

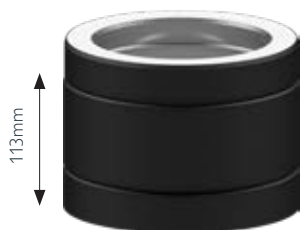

## 113mm length

SAP code	180115	180116	180117
Int Ømm	100	130	150
Ext Ømm	150	180	200

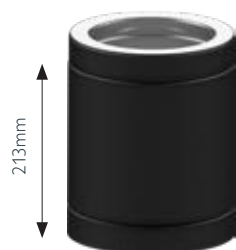

## 213mm length

SAP code	180112	180113	180114
Int Ømm	100	130	150
Ext Ømm	150	180	200



## 463mm length

SAP code	180109	180110	180111
Int Ømm	100	130	150
Ext Ømm	150	180	200



## 750mm length

SAP code	180106	180107	180108
Int Ømm	100	130	150
Ext Ømm	150	180	200



## 963mm length

SAP code	180103	180104	180105
Int Ømm	100	130	150
Ext Ømm	150	180	200



## Inspection pipe

SAP code	180306	180307	180308
Int Ømm	100	130	150
Ext Ømm	150	180	200

# Pipe lengths

Pipe lengths act as the primary building blocks of the chimney system, offered in various fixed and adjustable sizes to accommodate exact installation heights. These Core sections push fit connect using a secure locking band, ensuring continuous insulation and a flue gas tight seal along the entire run. Supplied with locking band.



## 1-piece adjustable 50-230mm

SAP code	180253	180254	180255
Int Ømm	100	130	150
Ext Ømm	150	180	200
ØA O/D	153	182.9	203

## 2 piece adjustable 250-365mm

SAP code	180755	180756	180757
Int Ømm	100	130	150
Ext Ømm	150	180	200

## 2-piece adjustable 360-580mm

SAP code	180256	180257	180258
Int Ømm	100	130	150
Ext Ømm	150	180	200
ØB O/D	148	178	198

## 2-piece adjustable 525-915mm

SAP code	180259	180260	180261
Int Ømm	100	130	150
Ext Ømm	150	180	200
ØB O/D	148	178	198

## Locking band

SAP code	180828	180829	180830
Int Ømm	100	130	150
Ext Ømm	150	180	200

## Structural locking band

SAP code	Coming soon		
Int Ømm	100	130	150
Ext Ømm	150	180	200

# Bends / Tees

Bends and tees provide the directional flexibility needed to navigate the chimney system around walls and other obstacles. Tees facilitate 90° or 135° connections while often incorporating a clean-out cap for easy maintenance, whereas angled bends allow for precise offsets to route the flue safely through walls or past roof overhangs. Supplied with locking band.



## 15° bend

SAP code	180169	180170	180171
Int Ømm	100	130	150
Ext Ømm	150	180	200
A	87.5	92.5	97.5
B	49.5	54.5	59.5



## 30° bend

SAP code	180172	180173	180174
Int Ømm	100	130	150
Ext Ømm	150	180	200
A	87.5	92.5	97.5
B	49.5	54.5	59.5

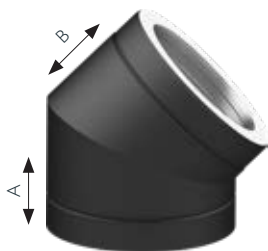

## 45° bend

SAP code	180175	180176	180177
Int Ømm	100	130	150
Ext Ømm	150	180	200
A	87.5	92.5	97.5
B	49.5	54.5	59.5

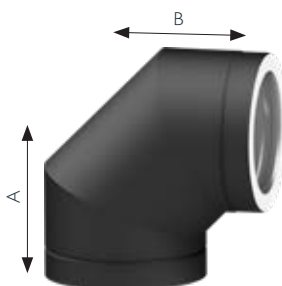

## 90° bend

SAP code	180178	180179	180180
Int Ømm	100	130	150
Ext Ømm	150	180	200
A	162	174	186
B	120	132	144

# Bends / Tees

Bends and tees provide the directional flexibility needed to navigate the chimney system around walls and other obstacles. Tees facilitate 90° or 135° connections while often incorporating a clean-out cap for easy maintenance, whereas angled bends allow for precise offsets to route the flue safely through walls or past roof overhangs. Supplied with locking band.

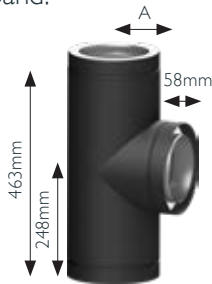

## 90° tee with sweeping access

SAP code	180185	180186	180187
Int Ømm	100	130	150
Ext Ømm	150	180	200
A	100	115	125

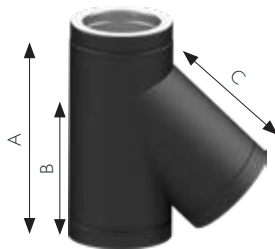

## 135° tee with sweeping access

SAP code	180188	180189	180190
Int Ømm	100	130	150
Ext Ømm	150	180	200
A	304	349	375
B	241	277	301
C	241	277	301



3/4 INCH  
BSP NIPPLE

## Tee plug with drain

SAP code	180250	180251	180252
Int Ømm	100	130	150
Ext Ømm	150	180	200

# Wall sleeves

These components act as a protective conduit for the chimney when it passes through external walls at a 45° or 90° angle. They provide a continuous and safe tunnel that shields the wall structure from heat, ensuring the Core pipe remains isolated and safe as it transitions from the interior to the exterior. Cut to length where required.

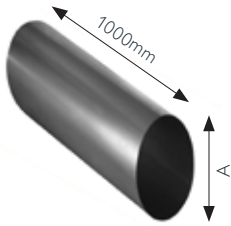

## Wall sleeve 45° / 135° non-combustible

SAP code	125894	126641	127205
Int Ømm	100	130	150
Ext Ømm	150	180	200
A	200	230	250

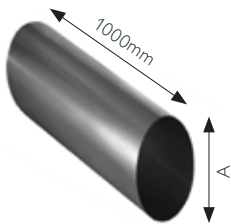

## Wall sleeve 45° / 135° combustible

SAP code	125895	126643	127207
Int Ømm	100	130	150
Ext Ømm	150	180	200
A	270	300	320

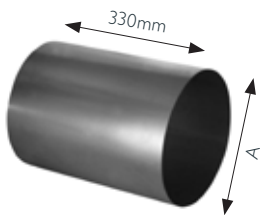

## Wall sleeve 90° non-combustible

SAP code	147392	126642	127206
Int Ømm	100	130	150
Ext Ømm	150	180	200
A	200	230	250

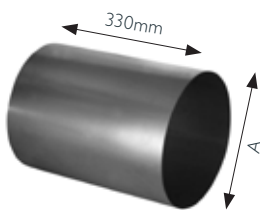

## Wall sleeve 90° combustible

SAP code	125897	126647	127212
Int Ømm	100	130	150
Ext Ømm	150	180	200
A	270	300	320

# G50 Firestops

Firestops are essential safety components designed to maintain the fire integrity of a building where the Core chimney passes through floors or walls. This allows 50mm distance to combustibles through floors and shafts when using fire rated heat proof board (Please refer to Installation Instructions)

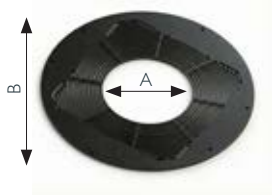

## 1-piece ventilated round firestop plate G50

SAP code	180077	180078	180079
Int Ømm	100	130	150
Ext Ømm	150	180	200
A	151.6	181.6	201.6
B	350	380	400

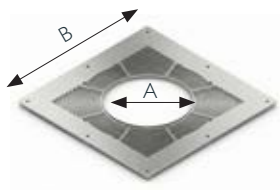

## 1-piece ventilated square firestop plate G50

SAP code	180080	180081	180082
Int Ømm	100	130	150
Ext Ømm	150	180	200
A	151.6	181.6	201.6
B	350	380	400

# G60 Firestops

The G60 range is designed for chimney runs where a wider 60mm clearance to combustibles is mandatory. This plate provides a robust structural barrier that guarantees the chimney remains centered and exactly 60mm away from potentially flammable building components.

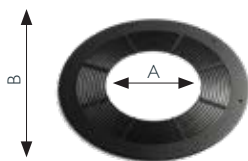

## 1-piece ventilated round firestop plate G60

SAP code	180746	180747	180748
Int Ømm	100	130	150
Ext Ømm	150	180	200
A	151.6	181.6	201.6
B	350	380	400

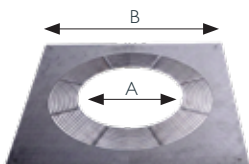

## 1-piece ventilated square firestop plate G60

SAP code	180749	180750	180751
Int Ømm	100	130	150
Ext Ømm	150	180	200
A	151.6	181.6	201.6
B	350	380	400

# Bungalow / single storey firestops

Bungalow firestop plates are solid firestops to allow the chimney through the ceiling into the attic area.

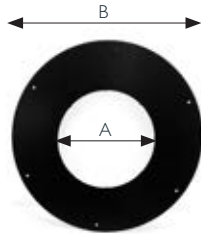

## 1-piece bungalow / single storey firestop

SAP black	180041	180042	180043
SAP white	180047	180048	180049
Int Ømm	100	130	150
A	151.6	181.6	201.6
B	350	380	400

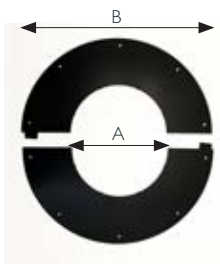

## 2-piece bungalow / single storey firestop

SAP black	180044	180045	180046
SAP white	180050	180051	180052
Int Ømm	100	130	150
A	151.6	181.6	201.6
B	350	380	400

# Support components

These components bear the weight of the chimney system, ensuring structural stability throughout the installation. Ranging from base supports and wall brackets to roof supports, these heavy-duty fixtures anchor the Core flue securely to the building's structure, preventing movement and carrying the load of the vertical run.

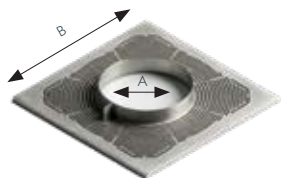

## G60 square 1-piece support plate

SAP code	180752	180753	180754
Int Ømm	100	130	150
Ext Ømm	150	180	200
A	151.6	181.6	201.6
B	350	380	400

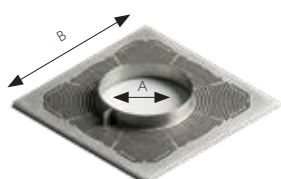

## G50 square 1-piece support plate

SAP code	180085	180083	180084
Int Ømm	100	130	150
Ext Ømm	150	180	200
A	151.6	181.6	201.6
B	350	380	400

## FEATURED PRODUCT

The retrofit wall support is an installer friendly and cost-effective installation solution providing flexibility on site.



## Retrofit wall support

SAP code	180312	180313	177315
Int Ømm	100	130	150
Ext Ømm	150	180	200
Adj. mm	60-225	60-210	60-200

## Retrofit wall support - extended

SAP code	180879	177314	170324
Int Ømm	100	130	150
Ext Ømm	150	180	200
Adj. mm	200-400	185-385	175-375



## Adjustable wall band 50-90mm

SAP code	180314	180315	180316
Int Ømm	100	130	150
Ext Ømm	150	180	200



## Adjustable wall band 90-200mm

SAP code	180807	180808	180809
Int Ømm	100	130	150
Ext Ømm	150	180	200

# Support components

These components bear the weight of the chimney system, ensuring structural stability throughout the installation. Ranging from base supports and wall brackets to roof supports, these heavy-duty fixtures anchor the Core flue securely to the building's structure, preventing movement and carrying the load of the vertical run.



## Adjustable wall band 190-300mm

SAP code	180810	180811	180812
Int Ømm	100	130	150
Ext Ømm	150	180	200



## Adjustable wall band 290-400mm

SAP code	180813	180814	180815
Int Ømm	100	130	150
Ext Ømm	150	180	200

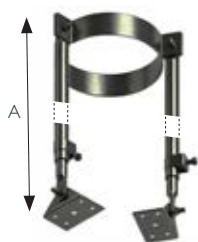

## Telescopic roof stays

SAP code	170141	170142	170143
Int Ømm	100	130	150
Ext Ømm	150	180	200
A	1600-2500	1600-2500	1600-2500



## Guy wire bracket

SAP code	180094	177339	137025
Int Ømm	100	130	150
A	150	180	200



## Roof support

SAP code	100961	100962	100963
Int Ømm	100	130	150
Ext Ømm	150	180	200

# Trim collars

Collars provide a neat and professional finish where the chimney passes through walls or ceilings. These are available in one piece or two piece variations to cover the expansion gap between the pipe and the surrounding surface, ensuring a clean aesthetic that blends the Core system seamlessly into the room's interior.

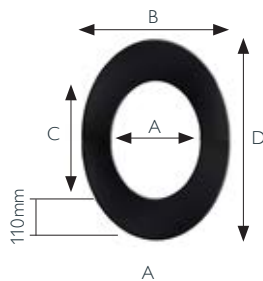

## 1-piece 45° / 135° trim collar

SAP code	180029	180031	180033
Int Ømm	100	130	150
Ext Ømm	150	180	200
A	154	184	204
B	374	404	424
C	216	259	287
D	436	479	507

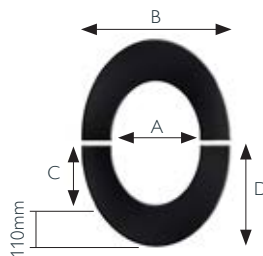

## 2-piece 45° / 135° trim collar

SAP code	180035	180037	180039
Int Ømm	100	130	150
Ext Ømm	150	180	200
A	154	184	204
B	374	404	424
C	108	129.5	143.5
D	218	239.5	253.5

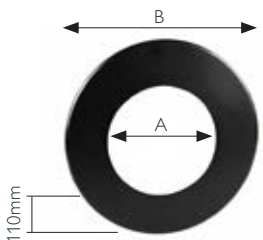

## 1-piece 90° trim collar

SAP code	180030	180032	180034
Int Ømm	100	130	150
Ext Ømm	150	180	200
A	154	184	204
B	300	330	350

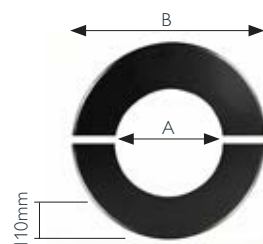

## 2-piece 90° trim collar

SAP code	180036	180038	180040
Int Ømm	100	130	150
Ext Ømm	150	180	200
A	154	184	204
B	374	404	424

# Trim collars

Collars provide a neat and professional finish where the chimney passes through walls or ceilings. These are available in one piece or two piece variations to cover the expansion gap between the pipe and the surrounding surface, ensuring a clean aesthetic that blends the Core system seamlessly into the room's interior.

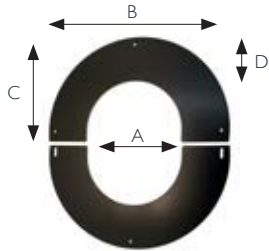

## Adjustable 0-20° trim collar

SAP code	179932	179933	179934
Int Ømm	100	130	150
Ext Ømm	150	180	200
A	154	184	204
B	374	404	424
C	209.5	224.5	234.5
D	110	110	110

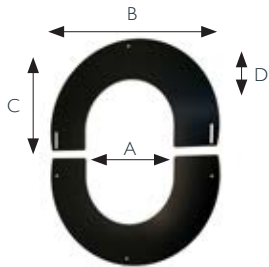

## Adjustable 20-35° trim collar

SAP code	179936	179937	179938
Int Ømm	100	130	150
Ext Ømm	150	180	200
A	154	184	204
B	374	405	424
C	224	245	261
D	110	110	110

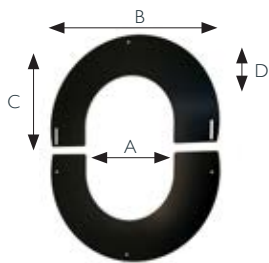

## Adjustable 35-45° trim collar

SAP code	179940	179941	179942
Int Ømm	100	130	150
Ext Ømm	150	180	200
A	154	184	204
B	374	404	424
C	241.5	269.5	282
D	110	110	110

# Terminals

Terminals are installed at the very top of the flue to ensure safe exhaust dispersion. From simple rain caps to anti-splash and anti-downdraught cowls, Core terminals protect the chimney from bird nesting, rain ingress, and wind pressure, ensuring consistent performance.

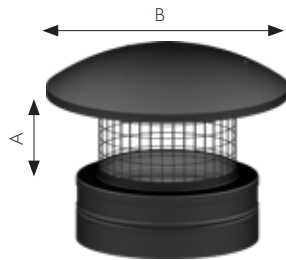

## Raincap with 25mm mesh

SAP code	180317	180318	180319
Int Ømm	100	130	150
Ext Ømm	150	180	200
A	70	90	90
B	266	266	310

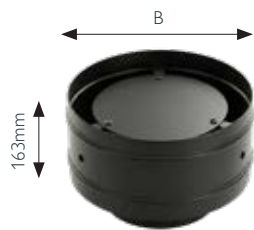

## Anti-downdraught round top terminal

SAP code	180742	180743	180744
Int Ømm	100	130	150
Ext Ømm	150	180	200
B	270	300	320

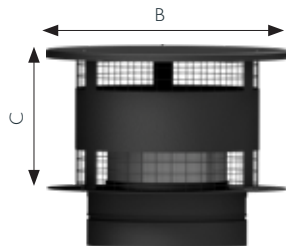

## Anti-splash / anti-downdraught terminal with 14mm mesh for gas/oil only

SAP code	180309	180310	180311
Int Ømm	100	130	150
Ext Ømm	150	180	200
B	234	254	304
C	95	143	171

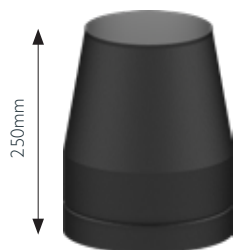

## Tapered terminal

SAP code	180191	180192	180193
Int Ømm	100	130	150
Ext Ømm	150	180	200

# Flashings

Flashings are the weatherproofing seal where the chimney penetrates the roof. They are formed to fit the roof pitch and tile profile, creating a watertight barrier around the Core pipe to prevent rain and moisture from entering the building structure.

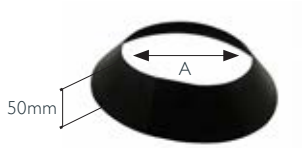

## Storm collar

SAP code	180098	18099	137028
Int Ømm	100	130	150
Ext Ømm	150	180	200
A	150	180	200

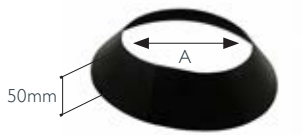

## Storm collar with seal

SAP code	Coming soon		
Int Ømm	100	130	150
Ext Ømm	150	180	200
A	150	180	200



## Angled flashing kit 5-45°

SAP code	180095	177336	177708
Int Ømm	100	130	150
Ext Ømm	150	180	200
A	700	700	700

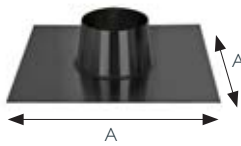

## Flat flashing kit

SAP code	180096	180097	137027
Int Ømm	100	130	150
Ext Ømm	150	180	200
A	700	700	700

# Accessories

Various optional accessories to maintain the chimney system or to enhance the installation.

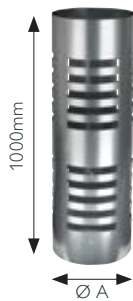

## Loft guard

SAP code	137464
Int Ømm	100 - 150
Ext Ømm	150 - 200
Ø A	320



## Touch up paint specific to finish

SAP code	180877
----------	--------

Black touch up spray paint for use with the standard Black satin RAL 9005 BLMT paint spec 400ml spray cans.

# 130mm offset tables

Offsets are made by assembling two bends or two bends and a pipe. On natural draught systems, there should be no more than 4 changes of direction of maximum 45°. Two 45° bends (or a 90° factory bend/tee) count as two changes of direction. The table below shows the 130mm offset measurements.

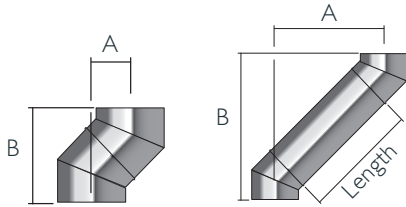

45° offset	A offset (mm)	B height (mm)
2x 45 Degree bends	104	251
113 Effective Length	184	331
213 Effective Length	255	402
463 Effective Length	431	578
750 Effective Length	634	781
963 Effective Length	785	895

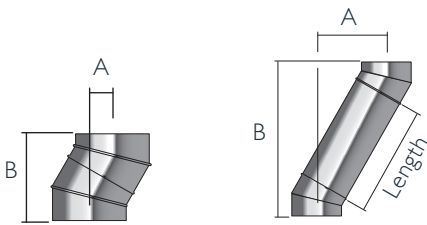

30° offset	A offset (mm)	B height (mm)
2x 30 Degree bends	74	274
113 Effective Length	130	372
213 Effective Length	180	459
463 Effective Length	305	675
750 Effective Length	449	924
963 Effective Length	555	1093

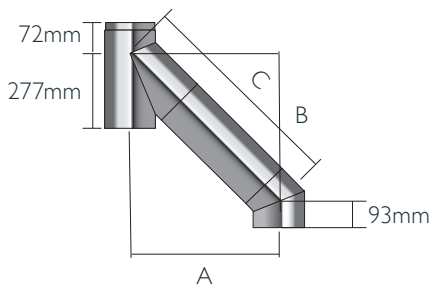

45 Bend into 135 Tee	A	B	C
No Length	234	234	332
113 Length	314	314	445
213 Length	385	385	545
463 Length	562	562	795
750 Length	765	765	1082
963 Length	915	915	1295

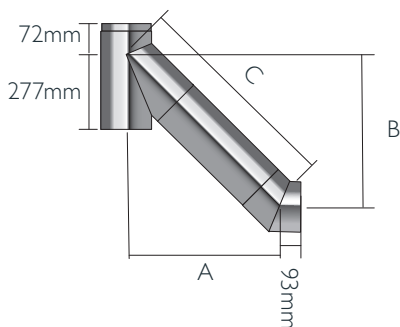

45 Bend into 135 Tee	A	B	C
No Length	234	234	332
113 Length	314	314	445
213 Length	385	385	545
463 Length	562	562	795
750 Length	765	765	1082
963 Length	915	915	1295

# 150mm offset tables

Offsets are made by assembling two bends or two bends and a pipe. On natural draught systems, there should be no more than 4 changes of direction of maximum 45°. Two 45° bends (or a 90° factory bend/tee) count as two changes of direction. The table below shows the 150mm offset measurements.

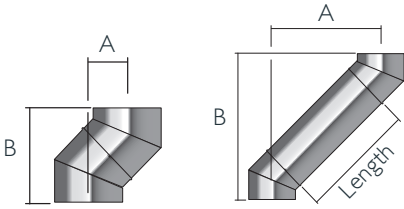

45° offset	A offset (mm)	B height (mm)
2x 45 Degree bends	111	268
113 Effective Length	191	348
213 Effective Length	262	419
463 Effective Length	438	595
750 Effective Length	641	798
963 Effective Length	792	949

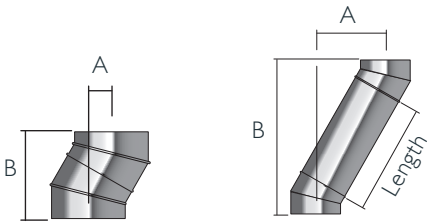

30° offset	A offset (mm)	B height (mm)
2x 30 Degree bends	79	293
113 Effective Length	135	391
213 Effective Length	185	477
463 Effective Length	310	694
750 Effective Length	454	942
963 Effective Length	560	1127

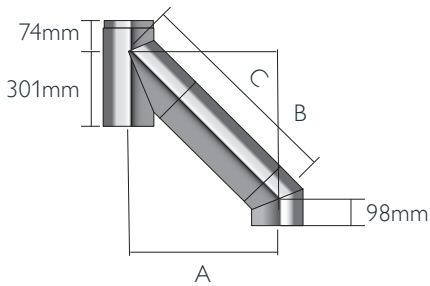

45 Bend into 135 Tee	A	B	C
No Length	255	255	361
113 Length	335	335	474
213 Length	406	406	574
463 Length	582	582	824
750 Length	785	785	1111
963 Length	936	936	1324

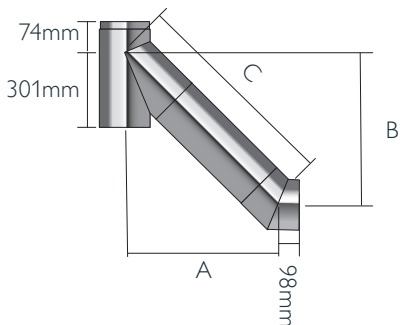

45 Bend into 135 Tee	A	B	C
No Length	255	255	361
113 Length	335	335	474
213 Length	406	406	574
463 Length	582	582	824
750 Length	785	785	1111
963 Length	936	936	1324

# System design

## OUTLET SITING

Flue terminations for wood burning are subject to EN15287-1 2010. The diagrams illustrate recommendations for the most commonly encountered outlet terminations. Adjacent taller structures may require increased height. The minimum flue projection through the roof is 600mm to the underside of the terminal.

## OUTLET SITING FOR CORE FLUE SYSTEM

Point where flue passes through weather surface	Clearance to flue outlet
A	At or within 600mm of the ridge
B	Elsewhere on the roof (whether pitched or flat)
C	Below (on a pitched roof) or within 2300mm horizontally to an openable roof-light, dormer window or other opening
D	Within 2300mm of an adjoining or adjacent building, whether or not beyond the boundary

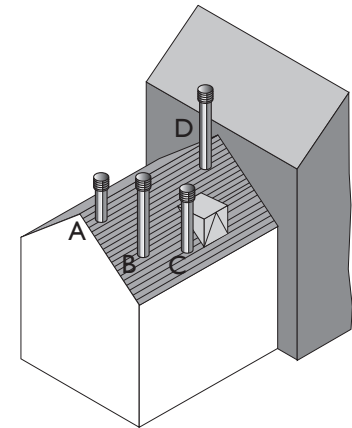

## TERMINATION AROUND VELUX STYLE OPENINGS FOR WOOD BURNING APPLIANCES

1. The weather surface is the building external surface, such as its roof, tiles or external walls.
2. A flat roof has a pitch less than 10°.
3. The clearance for A or B, as appropriate, will also apply.

A vertical flue fixed to an outside wall should be treated as equivalent to an inside flue emerging at the nearest edge of the roof.

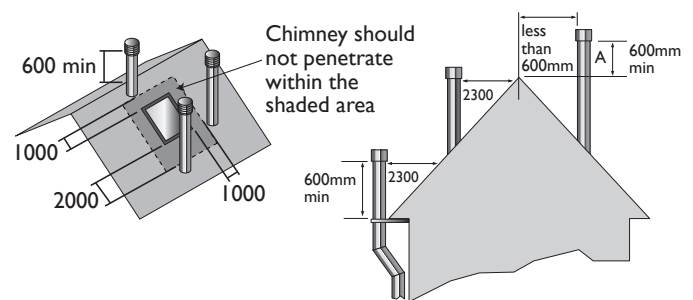

## TERMINAL TYPES

Raincaps and Anti-Splash terminals both come with mesh. Regular cleaning is required to avoid any blockages as a result of soot build up.

## FLUE ROUTING

The chimney should remain as straight as possible through its vertical run to assist flow. Should it be necessary to offset a chimney, it is recommended that a vertical rise of 600mm should be allowed immediately above the appliance before any change of direction.

Within a system, on all fuels, there should be no more than 4 changes of direction of maximum 45°.

90° Factory made bends or tees within the system may be treated as being equal to two 45° bends (see Document J of the Building Regulations issued October 1st 2010).

## PROVISION FOR SWEEPING, CLEANING AND MAINTENANCE

Provision should be made for inspecting and cleaning the chimney.

To aid cleaning, sufficient distance should be left between changes of direction to permit the safe passage of cleaning brushes within the system. This is particularly important on wood burning applications. It is recommended that chimneys serving wood burning appliances be swept as frequently as necessary but at least twice a year.

Choose an access component suitable for your installation unless cleaning/inspection can be done through the appliance.

# Load bearing data

Maximum load bearing (metres of pipe)			
Internal Diameter (mm)	100	130	150
Retrofit Wall Support	10	10	10
Ventilated Support Plate	12	12	12
Retrofit Wall Band	3	3	3
Guy Wire Bracket	1.5	1.5	1.5
Roof Support (above truss)	6	6	6
Roof Support (below truss)	4	4	4
Extension for Retrofit Wall Band	3	3	3

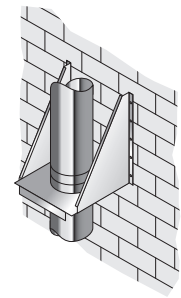

DIAGRAM A

Approximate weights of lengths (kg)			
Internal Diameter (mm)	100	130	150
1000mm	5.2	6.3	7.1
750mm	4.2	5.1	5.7
500mm	2.6	3.2	3.6
250mm	1.3	1.7	1.9
150mm	1.0	1.3	1.4

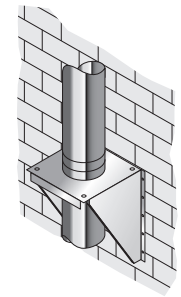

DIAGRAM B

## Installation

### MANDATORY REQUIREMENTS

We recommend the use of HETAS approved installers for wood burning applications. For full design and installation details the key referral documents are:

- BS EN 1856-1: Chimneys - System Chimney Products
- BS EN 1859: Metal Chimneys - Testing Methods
- BS EN 1443: Chimneys - General Requirements
- BS EN 15287-1: Chimneys. Design, installation and commissioning of chimneys. Chimneys for non-room sealed heating appliances.
- BS 5440-1: Flueing and ventilation for gas appliances of rated input not exceeding 70kW net (1st, 2nd and 3rd family gases)
- Specification for installation of gas appliances to chimneys and for maintenance of chimneys.
- Approved Document B (Fire safety): Dwellings (England)
- Approved Document J: - Combustion appliances and fuel storage systems (England & Wales)
- DFP Technical Booklet L: - Combustion appliances and fuel storage systems (NI)
- Technical Handbook (Domestic & Non Domestic), Section 3 - Environment (Scotland)
- Appliance Installation Instructions and related standards. Other standards covering specific applications will also be relevant and must be adhered to.
- Planning permission may be required, and reference should be made to the local Building Control Department.

### ENCLOSURE/SHAFTS

With the exception of the room containing the appliance, where the chimney passes through any part of the building, where there is a risk of accidental human contact, i.e. a bedroom etc., or where there is a risk of contact with combustible materials stored in a cupboard or in the roof-space, the chimney must be enclosed in an appropriate way to meet Building Regulations.

This can be achieved by boxing in the chimney in habitable rooms, or by the use of a protective wire mesh frame in roof spaces etc. In all cases the minimum distance to any combustible material, including loft insulation, must be respected according to the table on p.3, and any enclosure should be ventilated using the appropriate ventilated fire stops (see p.13/15). Enclosure must be constructed using materials consistent with guidance set out in Approved Document B.

# Installation

## DISTANCE TO COMBUSTIBLES

In accordance with building regulations it is essential that the correct distance to combustible material is maintained. On wood burning applications, where there is a risk of soot fire, a distance of 50mm or 60mm (depending on choice of G50 or G60 firestop plates) to combustibles must be maintained when passing through a combustible floor or enclosed within a shaft.

## ENGLAND / WALES

The installation must be carried out by a HETAS, OFTEC, NAPIT or APHC registered installer for England and Wales.

## SCOTLAND

All installations need to be carried out by a competent person this could be a NVQ qualified chimney sweep, HETAS, OFTEC, NAPIT or APHC registered installer, or have been approved by the local building control authority.

## BUNGALOWS

On bungalow applications where the chimney runs through either a combustible or non-combustible ceiling, an unventilated bungalow fire stop plate kit can be used. Please note that an unventilated support plate can not be used above the ceiling in this case. The weight of the chimney should be supported using the roof support. Distance to combustibles must be respected within the ceiling space and mesh frame should be used within the loft space, which must be ventilated.

## JOINTING SYSTEM

All joints in the Core Twin Wall range are made by means of a simple push-fit jointing method.

Joints are not permitted within wall and ceiling spaces. Any flue pipe (i.e. single wall) connection to the chimney must be made in the same room as the appliance. The chimney must project at least 425mm below the ceiling. Where a chimney passes through a wall, a wall sleeve must be used to prevent damage to the chimney and the building.

## CONNECTION TO APPLIANCE

Use the appropriate appliance connector, sealing with fire rope and fire cement or high temperature sealant on wood burning. The length of single-wall pipe on the

appliance connector can be trimmed where required.

## APPLIANCE REMOVAL

Use of an adjustable length immediately above the appliance enables removal of the appliance later without dismantling the full system.

## INSPECTION

To conform to Building Regulations, provisions should be made to enable a chimney to be inspected and cleaned. An inspection length or an insulated 90° or 135° Tee can form a suitable inspection point. To aid cleaning, sufficient distance should be left between changes of direction to permit the safe passage of cleaning brushes within the system. This is particularly important on wood burning applications. It is recommended that chimneys serving wood burning appliances be swept as frequently as necessary, but at least twice a year.

## CHIMNEY DIAMETER

The chimney size should be as recommended by the appliance manufacturer. Where there is a requirement for a flue diameter smaller than the appliance spigot, then the operational requirements of the appliance and the configuration of the flue must satisfy the flue sizing requirements of EN13384-1 for single appliances.

Core is available in internal diameters of 100mm, 130mm and 150mm. External is 150mm, 180mm and 200mm.

# Guarantee

## LIFE EXPECTANCY AND GUARANTEE

We are confident in our products and so offer you (the owner) a generous guarantee in relation to the Core Twin Wall system (the System). Provided that you comply with the conditions stated below, the system will be free from defects for 10 years.

The conditions of the guarantee are:

- Correctly sized and installed in accordance with the manufacturer's instructions, current Building Regulations and relevant British and European standards.
- Maintained correctly by a qualified and competent person and maintenance records kept updated for both appliance and chimney/chimney liner (i.e. sweeping certificates).
- Used in combination with an appliance burning only approved fuels in accordance with Schiedel Chimney Systems and the appliance manufacturer's instructions.
- No overnight burning (slumbering) can occur.
- Familiarise yourself with the installation instructions and comply with its provisions in full during the lifetime of your usage of the product (including by keeping the required records safe). Failure to do so will invalidate any guarantee claim.

For more details about the guarantee visit our website. For recommended fuels listings, please refer to the HETAS Guide [www.hetas.co.uk](http://www.hetas.co.uk)

In the event of a fault developing in the product due to defective materials or faulty manufacture Schiedel Chimney Systems undertake to replace the product only. Schiedel Chimney Systems cannot accept liability nor take any responsibility for the installation, building or redecorating costs or any other consequential losses arising. If any complaint is found to be a result of faulty installation, non-compliance with or abuse contrary to these conditions, the cost of site investigation is chargeable.

## Frequently asked questions

### ARE THERE OTHER FINISHES AVAILABLE?

We are only launching the black product initially. No plans are currently in place to introduce any additional painted variants, or an unpainted version

### WHAT IS THE WARRANTY/GUARANTEE PERIOD?

The warranty period for Core Twin Wall will be 10 years, with the usual caveats to this guarantee; Installed to our instructions, swept regularly, carried out by a HETAS registered installer/competent person etc.

## Schiedel Installer Rewards

Exciting news from Schiedel Chimney Systems for stove and chimney Installers!

Whenever you register an installation with our easy to use, online guarantee registration portal, you will now accrue points based on the number of installations and installation type.

**Once you have reached a minimum of 25 points, you can begin to redeem them for £25 Love2Shop vouchers.**

So head on over to the portal and start to register your installations to take full advantage of our guarantee and also to start earning points!



**SCHIEDEL**

**Schiedel Chimney Systems**  
Crowther Estate, Washington  
Tyne & Wear NE38 0AQ  
Tel. +44 (0)191 416 1150

[sales.uk@schiedel.com](mailto:sales.uk@schiedel.com)  
[schiedel.com/uk](http://schiedel.com/uk)

Follow us on Social Media @SchiedelUK



**A standard**  
INDUSTRIES COMPANY

Please note that an updated version of this brochure is always available online <https://www.schiedel.com/uk>