

JUPITER 470 XL

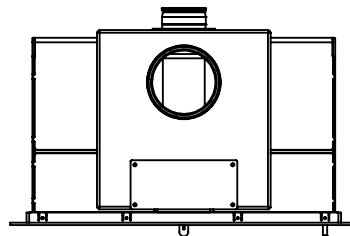

JUPITER 470 XL FRISKLIFT BAG.

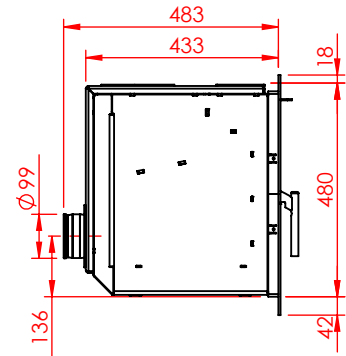
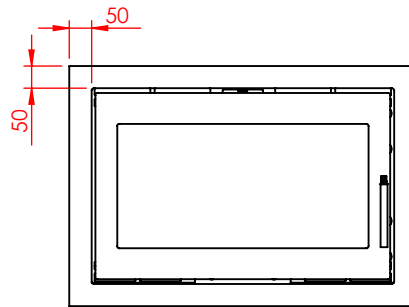
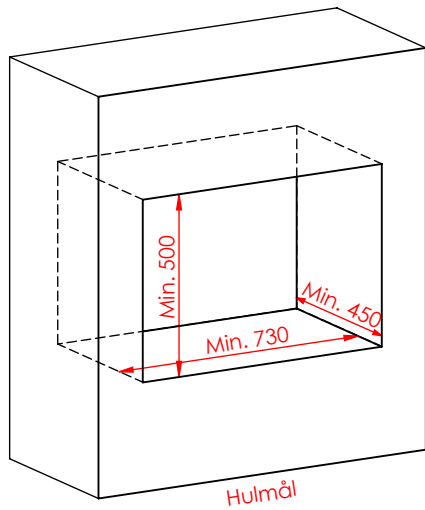
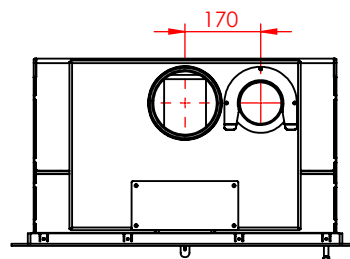
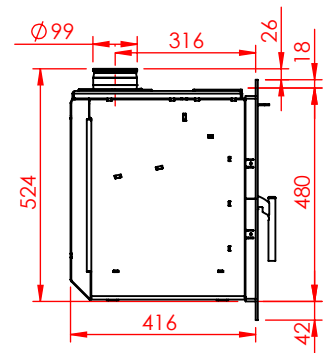
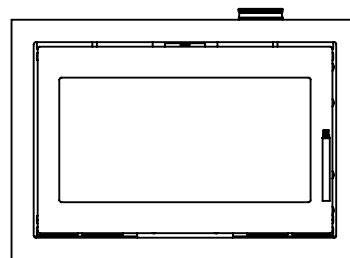
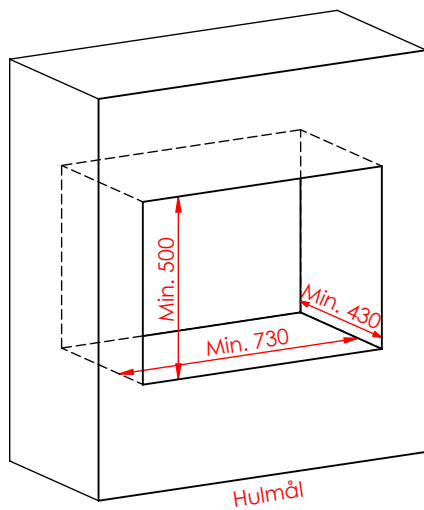

JUPITER 470 XL FRISKLIFT TOP.

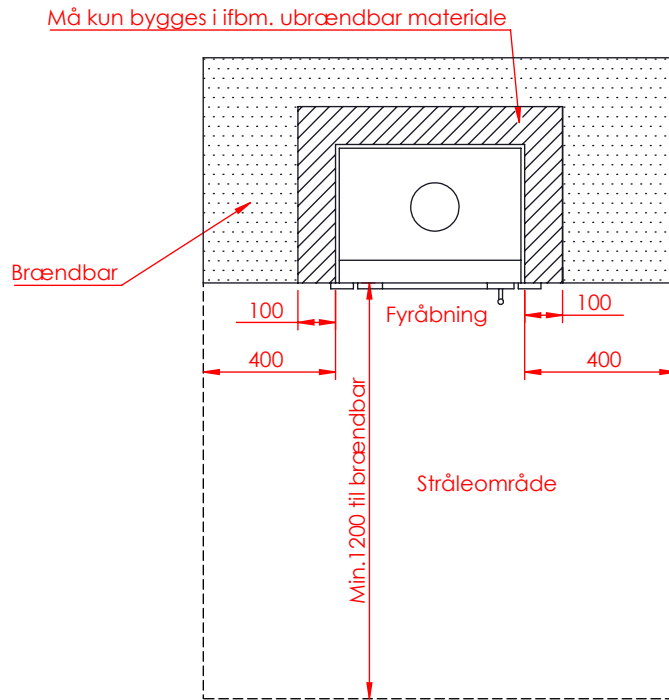

AFSTAND TIL BRÆNDBART.

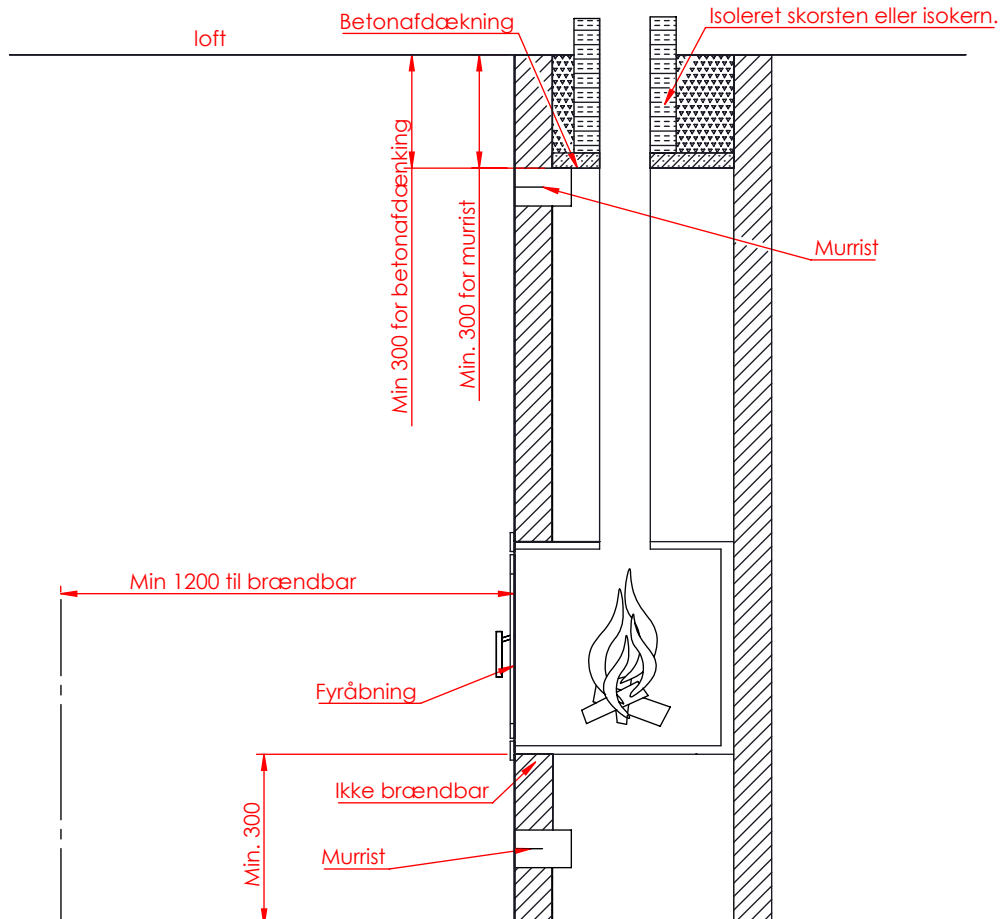

AFSTAND TIL BRÆNDBART.

DATA: JUPITER 470 XL

Jupiter 470 XL	
Glasmål:	578 x 292 mm.
Driftseffekt:	3 - 9 Kw
Nominel ydelse:	6,7 Kw
Røgstuds:	150 mm.
Virkningsgrad:	79 %
Ekstraudstyr:	Rysterist.
Ekstraudstyr:	Friskluft.