

JUPITER 550

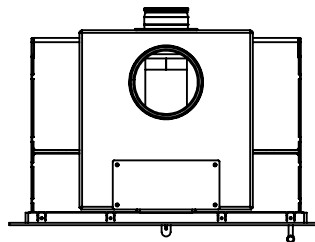

JUPITER 550 FRISKLIFT BAG.

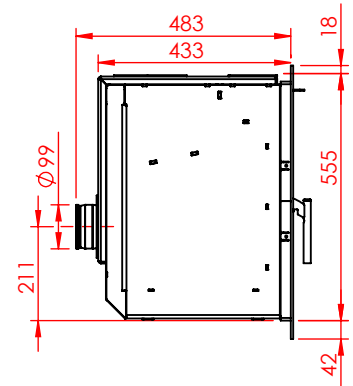
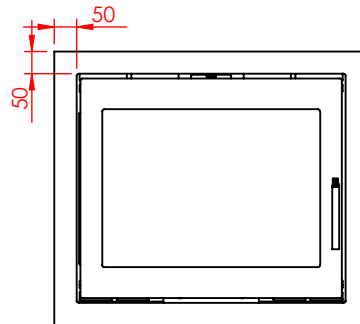
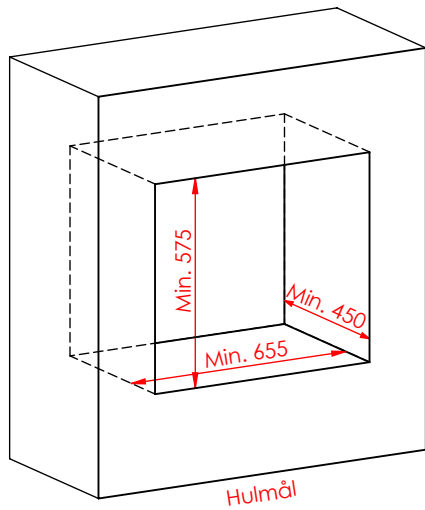
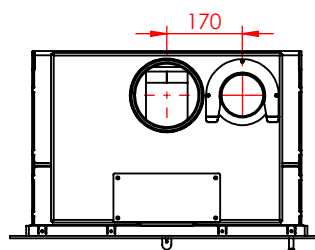
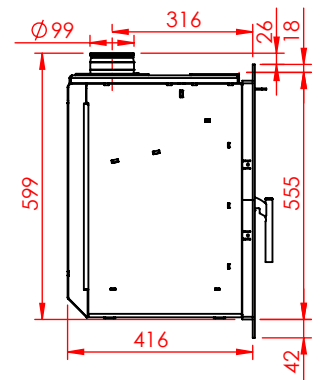
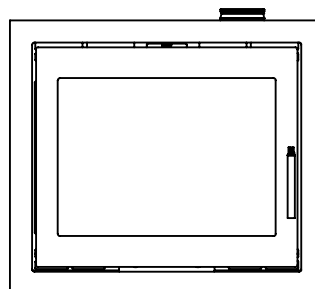
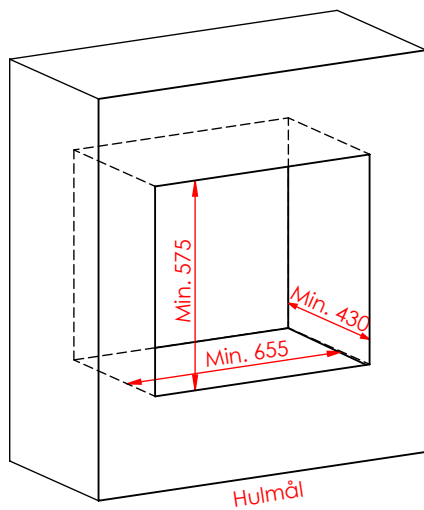

JUPITER 550 FRISKLIFT TOP.

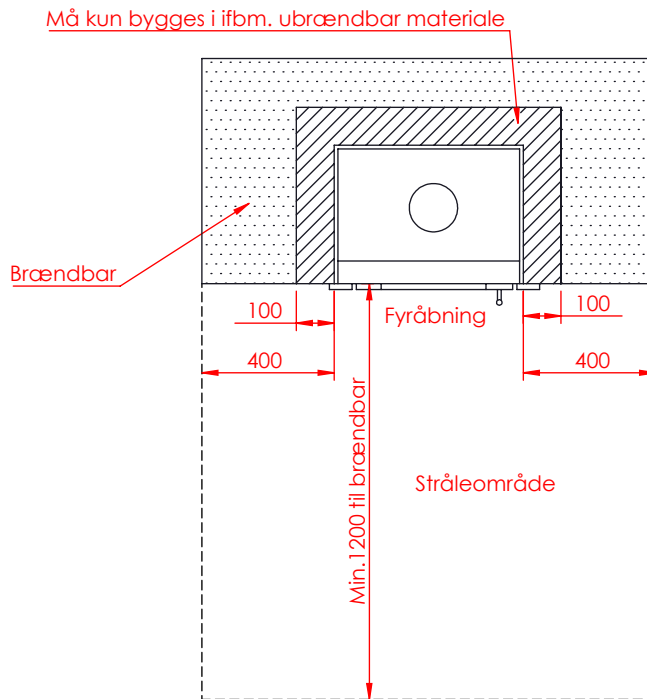

AFSTAND TIL BRÆNDBART.

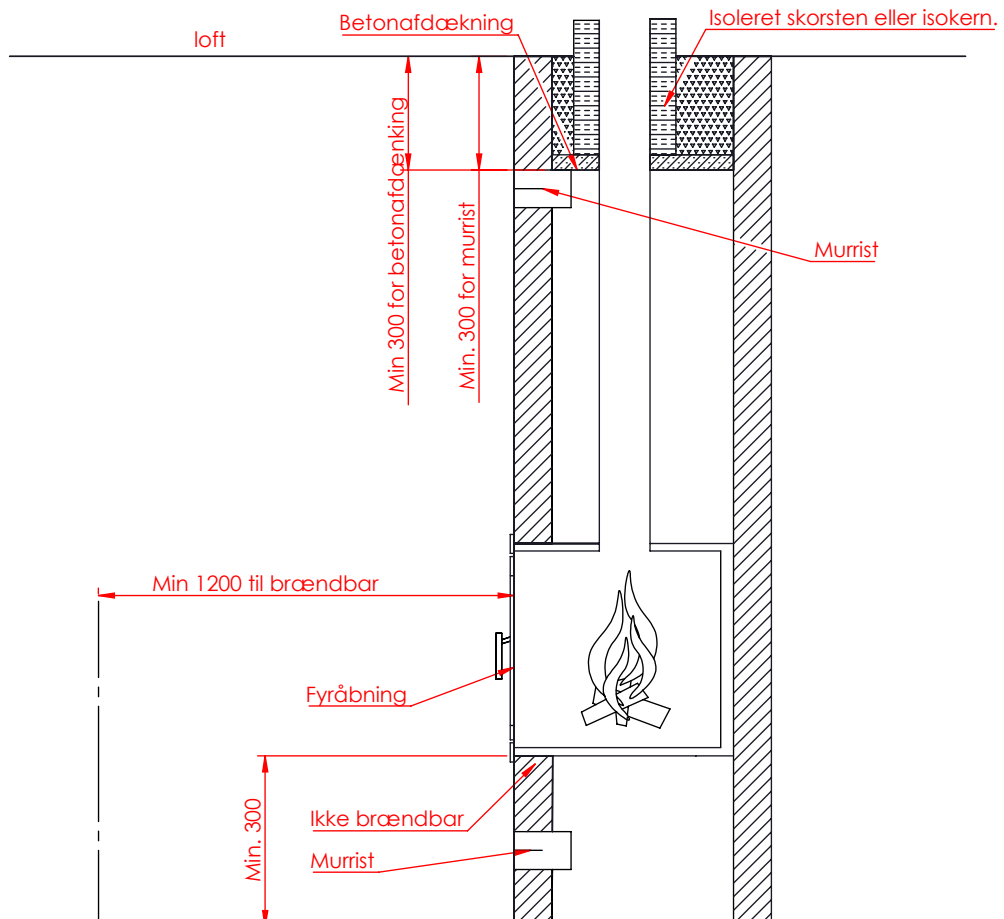

AFSTAND TIL BRÆNDBART.

DATA: JUPITER 550

Jupiter 550	
Glasmål:	503 x 367 mm.
Driftseffekt:	3 - 9 Kw
Nominel ydelse:	6,2 Kw
Røgstuds:	150 mm.
Virkningsgrad:	79 %
Ekstraudstyr:	Rysterist.
Ekstraudstyr:	Friskluft.