

SCHIEDEL METALOTERM



Metaloterm Vantage

Twin Wall Insulated Chimney System



System Description

Vantage is a quality twin wall chimney system with a quick lock jointing system. It is used for wood burning or for solid fuel stoves. With a quick lock jointing system. The components have a twin wall construction with a male spigot and a female socket to provide simple and rapid installation.

With its fully sealed components, **Vantage** can be installed both internally and externally. **Vantage** is supplied with a ten year conditional warranty.

Applications

- Gas-fired stoves
- Wood-fired stoves
- Approved solid fuels
- Oil-fired appliances

Key Features

- 10 year warranty
- Suitable for internal and external applications
- Distance to combustibles 60mm (50mm in free air)
- Also available in black powder coated finish
- Easy to install Twist-lock system
- Weatherproof, fully sealed components
- High density, mineral wool insulation
- Made from high grade stainless steel
- 316L stainless steel inner wall for the highest corrosion resistance
- 304 stainless steel outer wall in an attractive, polished finish

CE marking

Metal system chimney section	EN 1856-1 EN 1856-1 EN 1856-1 EN 1856-1	T450 T600 T450 T600	N1 N1 N1 N1	D D D D	V3 L50050 V3 L50050 V3 L50050 V3 L50050	G50 G50 G60 G100	} in free air } in combustible shaft with ventilated fire stop
Product description	Standard number	Temperature level	Pressure level (N: negative pressure, P: positive pressure, H: high positive pressure)	Condensate resistance (W: wet/D: dry)	Corrosion-resistance class and flueliner specification	Soot fire resistance (G: Yes O: No) and distance to combustible material (in mm)	

Technical characteristics

Technical characteristics				
Application	Chimney/Flue system			
Operating mode	Dry			
Pressure	Negative pressure			
Operating Temperature	450 °C / 600 °C			
Thermal Shock	1000 °C [max 30 min]			
Inner Wall	material	AISI 316L/EN 1.4404		
	thickness	0.5 mm		
Outer wall	material	AISI 304 BA/EN 1.4301		
	thickness	0.5 mm		
Insulation	type	Mineral wool		
	thickness	25 mm		
Fuel Type	Wood/Gas/Oil/Approved Solid Fuels			
ID mm	125(5")	150(6")	175(7")	200(8")
OD mm	175	200	230	250
Cross section cm ²	123	177	241	314
Weight ±kg/m	5.5	6.5	7.5	8.0
Chimney diameter				
The chimney size should be as recommended by the appliance manufacturer. Where there is a requirement for a flue diameter smaller than the appliance spigot, then the operational requirements of the appliance and the configuration of the flue must satisfy the flue sizing requirements of EN13384—1 for single appliances.				
CE approved				
EN1856: T450 N1 D V3 L50050 G50 [in free air]				
EN1856: T450 N1 D V3 L50050 G60 [in a combustible shaft with ventilated fire stops]				
EN1856: T600 N1 D V3 L50050 G100 [in a combustible shaft with ventilated fire stops]				

Joint design and construction

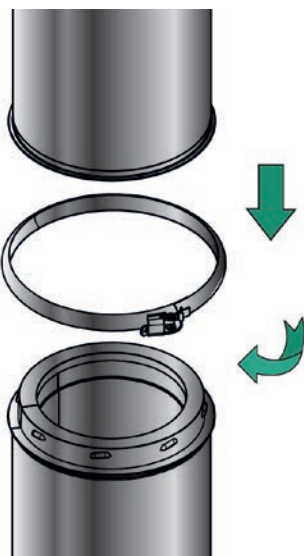

The joint is made by fitting the female end over the male end and engaging the joint system by rotating the component clockwise. A locking band is then fitted to secure the joint, as shown. The Vantage joint incorporates an eight barb twist lock coupler system to allow easy and rapid installation of the product.

Starter Components



Stove Pipe Starter Section (short)

Use this adaptor to join single wall, enamelled flue pipe to your twin wall. Both the single and twin wall flue pipe must be of the same diameter to use this product. Locking band included. Short tapered version.

Ø	125	150	175	200
OD	122	147	172	197
Old Code	EXSTA13	EXSTA15	EXSTA18	EXSTA20
SAP Code	165567	165569	165571	165573
SAP Code Painted	165568	165570	165572	165574

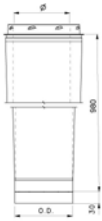

Stove Pipe Starter Section (long)

Use this adaptor to join single wall, enamelled flue pipe to your twin wall. Both the single and twin wall flue pipe must be of the same diameter to use this product. Locking band included. Long tapered version.

Ø	125	150	175	200
OD	122	147	172	197
Old Code	EXLTA13	EXLTA15	EXLTA18	EXLTA20
SAP Code	165447	165449	165451	165453
SAP Code Painted	165448	165450	165452	165454

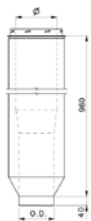

Increasing Stove Pipe Starter Section

This allows you to join a 100 mm, 125 mm, 150 mm or 175 mm single wall, enamelled flue pipe to a larger 125 mm, 150 mm, 175 mm or 200 mm twin wall pipe. Included locking band.

Ø	125	150	175	200
OD	97	122	147	172
Old Code	EXAX13	EXAX15	EXAX18	EXAX20
SAP Code	165329	165331	165333	165335
SAP Code Painted	165330	165332	165334	165336

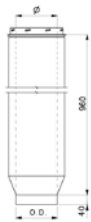

Stove Pipe Starter Section

Use this adaptor to join single wall, enamelled flue pipe to your twin wall. Both the single and twin wall flue pipe must be of the same diameter to use this product. Locking band included.

Ø	125	150	175	200
OD	122	147	172	197
Old Code	EXAZ13	EXAZ15	EXAZ18	EXAZ20
SAP Code	165337	165339	165341	165343
SAP Code Painted	165338	165340	165342	165344

Adaptors

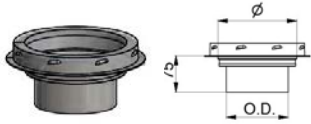

Increasing Adaptor

This allows you to join a 100 mm, 125 mm, 150 mm or 175 mm single wall, enamelled flue pipe to a larger 125 mm, 150 mm, 175 mm or 200 mm twin wall application. Locking band included.

Ø	125	150	175	200
OD	97	122	147	172
Old Code	EXIA13	EXIA15	EXIA18	EXIA20
SAP Code	165413	165415	165417	165419
SAP Code Painted	165414	165416	165418	165420

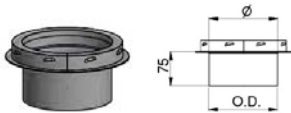

Single Wall Adaptor

Use this adaptor to join single wall, enamelled flue pipe to your twin wall. Both the single and twin wall flue pipe must be of the same diameter to use this product. Locking band included.

Ø	125	150	175	200
OD	122	147	172	197
Old Code	EXAD13	EXAD15	EXAD18	EXAD20
SAP Code	165313	165315	165317	165319
SAP Code Painted	165314	165316	165318	165320

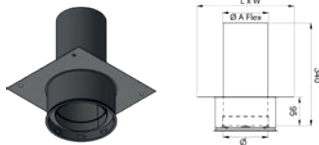

Counter Adaptor To Flex

Used to connect Vantage to flexible flue liner

Ø	125	150	175	200
OD	125	150	180	200
LxW	300x300	320x300	355x335	375x356
Old Code	EXAFC13	EXAFC15	EXAFC18	EXAFC20
SAP Code	167031	167033	167035	167037
SAP Code Painted	167032	167034	167036	167038

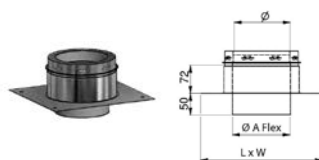

Adaptor From Flex

Used to connect flexible flue liner to Vantage.

Ø	125	150	175	200
OD	125	150	180	200
LxW	300x300	320x300	355x335	375x356
Old Code	EXAF13	EXAF15	EXAF18	EXAF20
SAP Code	167023	167025	167027	167029
SAP Code Painted	167024	167026	167028	168030

Pipe Lengths

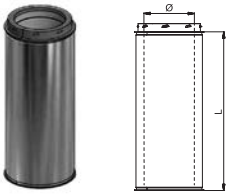

Pipe Length

Available in 5 lengths which can be easily combined to achieve the required height for the installation. All lengths must be installed with the male socket pointing upwards. Locking band included.

	Old Code	SAP Code	Painted	Old Code	SAP Code	Painted	Old Code	SAP Code	Painted	Old Code	SAP Code	Painted	Old Code	SAP Code	Painted
Nominal Length	145			255			525			755			1025		
Effective Length (L)	120			200			500			750			1000		
Ø125	EX1213	165285	165286	EX2013	165289	165290	EX5013	165297	165298	EX7513	165305	165306	EX10013	165277	165278
Ø150	EX1215	165287	165288	EX2015	165291	165292	EX5015	165299	165300	EX7515	165307	165308	EX10015	165279	165280
Ø175	EX1218			EX2018	165293	165294	EX5018	165301	165302	EX7518	165309	165310	EX10018	165281	165282
Ø200	EX1220			EX2020	165295	165296	EX5020	165303	165304	EX7520	165311	165312	EX10020	165283	165284

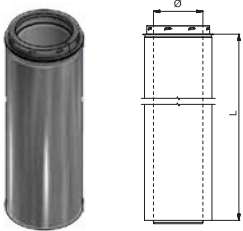

Adaptor Length For Single Wall

Use this adaptor to join single wall, enamelled flue pipe to your twin wall. With its telescopic function this adaptor is easy to install, flexible connection and give a completely seamless join. Locking band included.

Ø	125	150	175	200
Old Code	EXAL13	EXAL15	EXAL18	EXAL20
SAP Code	165321	165323	165325	165327
SAP Code Painted	165322	165324	165326	165328

Pipe Lengths

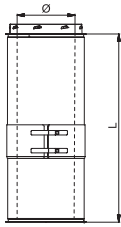

Adjustable Length

The two-part adjustable length offers a degree of flexibility when standard length dimensions are not suitable. Locking band included.

	Old Code	SAP Code	Painted
Nominal Length	320-520	320-520	320-520
Effective Length (L)	295-495	295-495	295-495
ø125	EXPP13	165499	165500
ø150	EXPP15	165501	165502
ø175	EXPP18	165503	165504
ø200	EXPP20	165505	165506

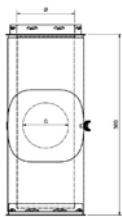

Inspection Element

Used as an inspection opening to inspect and maintain the chimney. Locking band included.

	125	150
Old Code	EXIH13	EXIH15
SAP Code	165421	165423
SAP Code Painted	165422	165424

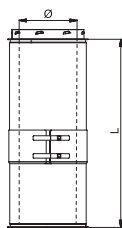

Adjustable Length (long)

The two-part adjustable length offers a degree of flexibility when standard length dimensions are not suitable. Locking band included.

	Old Code	SAP Code	Painted
Nominal Length	525-975	525-975	525-975
Effective Length (L)	500-950	500-950	500-950
ø125	EXPPL13	165507	165508
ø150	EXPPL15	165509	165510
ø175	EXPPL18	165511	
ø200	EXPPL20	165512	

Elbows

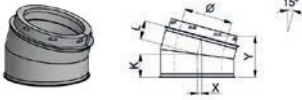

Elbow 15°

The female elbow sockets are provided without locking barbs to enable them to be easily rotated to achieve the required direction for installation. Locking band included.

Ø	125	150	175	200
K	61	63	64	66
L	48	50	52	53
X	14	15	15	16
Y	107	111	114	117
Old Code	EXB1513	EXB1515	EXB1518	EXB1520
SAP Code	165345	165347	165349	165351
SAP Code Painted	165346	165348	165350	165352

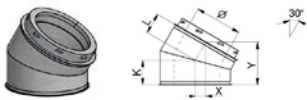

Elbow 30°

The female elbow sockets are provided without locking barbs to enable them to be easily rotated to achieve the required direction for installation. Locking band included.

Ø	125	150	175	200
K	64	70	73	97
L	60	60	65	84
X	31	33	35	46
Y	116	122	129	169
Old Code	EXB3013	EXB3015	EXB3018	EXB3020
SAP Code	165353	165355	165357	165359
SAP Code Painted	165354	165356	165358	165360

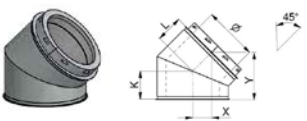

Elbow 45°

The female elbow sockets are provided without locking barbs to enable them to be easily rotated to achieve the required direction for installation. Locking band included.

Ø	125	150	175	200
K	79	80	91	95
L	70	75	82	86
X	53	55	61	64
Y	127	133	148	155
Old Code	EXB4513	EXB4515	EXB4518	EXB4520
SAP Code	165361	165363	165365	165367
SAP Code Painted	165362	165364	165366	165368

Elbows

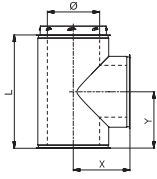

Tee piece 90°

Used as the entry to a vertical chimney from a horizontal stove outlet or as an inspection opening. Locking band included.

Ø	125	150	175	200
L	300	327	350	375
X	128	170	193	210
Y	150	165	180	195
Old Code	EXT9013	EXT9015	EXT9018	EXT9020
SAP Code	165591	165593	165595	165597
SAP Code Painted	165592	165594	165596	165598

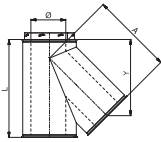

Tee piece 45°

Used at the base of a vertical chimney, or to allow a smooth transition from the horizontal to vertical plain when used with a 45° elbow. The female sockets are provided without locking bars to enable them to be easily rotated to achieve the required direction for installation. Locking band included.

Ø	125	150	175	200
L	330	360	400	430
Y	261	282	303	325
A	270	300	330	360
Old Code	EXT4513	EXT4515	EXT4518	EXT4520
SAP Code	165583	165585	165587	165589
SAP Code Painted	165584	165586	165588	165590

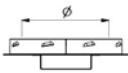

Tee Plug

Provides access to the system for inspection and cleaning.

Ø	125	150	175	200
Old Code	EXTE13	EXTE15	EXTE18	EXTE20
SAP Code	165599	165601	165603	165605
SAP Code Painted	165600	165602	165604	165606

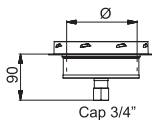

Drain plug

Used at the bottom of a vertical chimney to facilitate drainage. Fitted with a stainless steel 3/4" BSP external thread drain connection. Locking band and 3/4" cap included.

Ø	125	150	175	200
Old Code	EXRBK13	EXRBK15	EXRBK18	EXRBK20
SAP Code	165513	165515	165517	165519
SAP Code Painted	165514	165516	165518	165520

Support Components

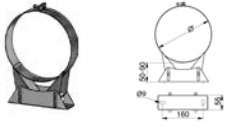

Wall band adjustable

Wall bands provide lateral support at a distance of 50 mm to 90 mm from the wall. The chimney must be used at intervals not exceeding 3.0 metres beyond any load bearing support.

Ø	125	150	175	200
Old Code	EXWB13	EXWB15	EXWB18	EXWB20
SAP Code	165615	165617	165619	165621
SAP Code Painted	165616	165618	165620	165622

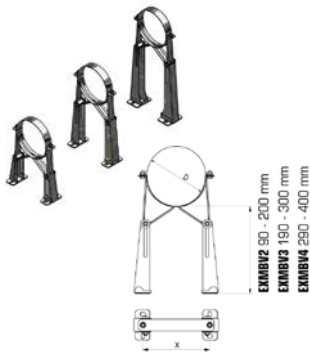

Wall band adjustable

90 - 200 mm
190 - 300 mm
290 - 400 mm

Ø	125	150
X	205	230
D	175	200
Old Code 90-200	EXMBV213	EXMBV215
SAP Code	165455	165457
SAP Code Painted	165456	165458
Old Code 190-300	EXMBV313	EXMBV315
SAP Code	165459	165461
SAP Code Painted	165460	165462
Old Code 290-400	EXMBV413	EXMBV415
SAP Code	165463	165465
SAP Code Painted	165464	165466

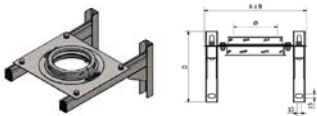

Base support 0 - 200 mm plate

Used to take the vertical load of the chimney when supported from a wall. Supports Max 15m.

Ø	125	150	175	200
AxB	475x325	475x350	475x375	475x400
D	242	242	242	242
Old Code	EXOH213	EXOH215	EXOH218	EXOH220
SAP Code	165467	165468	165469	165470
SAP Code Painted	165475	165476	165477	165478

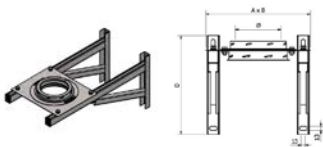

Base support 0 - 400 mm plate

Used to take the vertical load of the chimney when supported from a wall. Supports Max 15m.

Ø	125	150	175	200
AxB	740x325	740x350	740x375	740x400
D	242	242	242	242
Old Code	EXOH413	EXOH415	EXOH418	EXOH420
SAP Code	165471	165472	165473	165474

Support Components

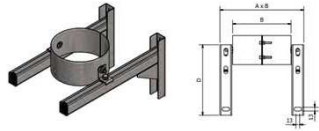

Base support 0 - 200 mm band

Used to take the vertical load of the chimney when supported from a wall. Supports Max 10m.

Ø	125	150	175	200
AxB	475x325	475x350	475x375	475x400
D	242	242	242	242
Old Code	EXOHZ213	EXOHZ215	EXOHZ218	EXOHZ220
SAP Code	165483	165485	165487	165489
SAP Code Painted	165484	165486	165488	165490

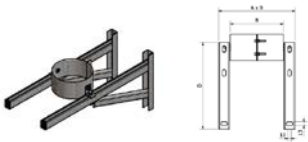

Base support 0 - 400 mm band

Used to take the vertical load of the chimney when supported from a wall. Supports Max 10m.

Ø	125	150	175	200
AxB	740x325	740x350	740x375	740x400
D	242	242	242	242
Old Code	EXOHZ413	EXOHZ415	EXOHZ418	EXOHZ420
SAP Code	165491	165493	165495	165497
SAP Code Painted	165492	165494	165496	165498

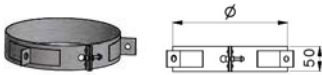

Guy wire band

A clamping collar for the attachment of struts/supports.

Ø	125	150	175	200
Old Code	EXGWB13	EXGWB15	EXGWB18	EXGWB20
SAP Code	165405	165407	165409	165411
SAP Code Painted	165406	165408	165410	165412

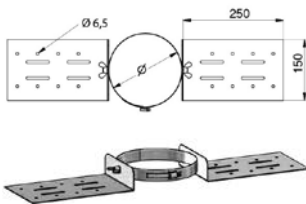

Roof support

This can be fixed to roof joists to give added support to the system.

This can support up to 2m above the rafter. Support without a roof bracing kit.

Ø	125	150	175	200
Old Code	EXRSB13	EXRSB15	EXRSB18	EXRSB20
SAP Code	165529	165531	165533	165535
SAP Code Painted	165530	165532	165534	165536

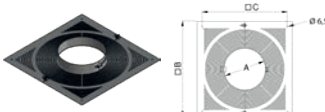

Ventilated ceiling support G60

This can be fixed on a horizontal ceiling/floor to give added support to the system. This can support up to 6m above the loft floor. Used for max T450 applications.

Ø	125	150	175	200
A	340	360	390	410
B	340	360	390	410
C	290	310	330	360
Old Code	EXCSP13	EXCSP15	EXCSP18	EXCSP20
SAP Code	165369	165371	165373	165375
SAP Code Painted	165370	165372	165374	165376

Support Components

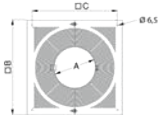
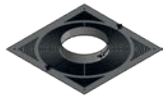

Ventilated Ceiling Support G100

This can be fixed on a horizontal ceiling/floor to give added support to the system. This can support up to 6m above the loft floor. Used for max T600 applications.

Ø	125	150	175	200
A	440	465	490	515
B	340	360	390	410
C	290	310	330	360
Old Code	EXCSP13	EXCSP15	EXCSP18	EXCSP20
SAP Code	167039	167041	167043	167045
SAP Code Painted	167040	167042	167044	167046

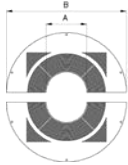

Ventilated Firestop G60

Combustible floor, round ventilated Firestop Plate, 2 pieces. Used for max T450 applications

Ø	125	150	175	200
A	181	206	231	256
B	425	460	495	525
Old Code	EXCSPR213	EXCSPR215	EXCSPR218	EXCSPR220
SAP Code	165397	165399	165401	165403
SAP Code Painted	165398	165400	165402	165404

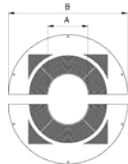

Ventilated Firestop G100

Combustible floor, round ventilated Firestop Plate, 2 pieces. Used for max T600 applications

Ø	125	150	175	200
A	181	206	231	256
B	425	460	495	525
Old Code	EXFSRG13	EXFSRG15	EXFSRG8	EXFSRG20
SAP Code	167055	167057	167059	167061
SAP Code Painted	167056	167058	167060	167062

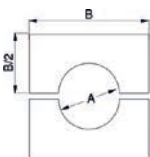

Square Firestop Unventilated

The unventilated 2-piece firestop is used where the chimney penetrates through a non-combustible floor.

Ø	125	150	175	200
A	181	206	231	256
B	381	406	431	456
Old Code	EXETPS13	EXETPS15	EXETPS8	EXETPS20
SAP Code	167047	167049	167051	167053
SAP Code Painted	167047	167049	167051	167053

Support Components

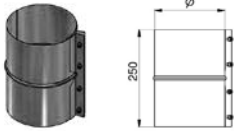

Reinforced locking band

Reinforced locking bands can be used to replace standard locking bands throughout the system. They are required for added support for lengths of flue in excess of 3 meters long. However where above roof level additional bracing may be required.

Ø	125	150	175	200
Old Code	EXSLB13	EXSLB15	EXSLB18	EXSLB20
SAP Code	165559	165561	165563	165565
SAP Code Painted	165560	165562	165564	165566



Locking Band

The standard locking band has a spring connection system, and comes with a circlip to join the mating parts for increased system integrity. It is supplied with every component that has a male socket.

Ø	125	150	175	200
Old Code	EXLB13	EXLB15	EXLB18	EXLB20
SAP Code	165425	165427	165429	165431
SAP Code Painted	165426	165428	165430	165432

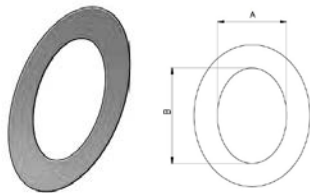

45° Wall Cover Ring

The wall cover ring is designed to cover the chimney where it penetrates a wall at a 45° angle.

Ø	125	150	175	200
AxB	179	204	230	255
D	253	288	325	360
Old Code	EXETP13	EXETP15	EXETP18	EXETP20
SAP Code	165377	165379	165381	165383
SAP Code Painted	165378	165380	165382	165384

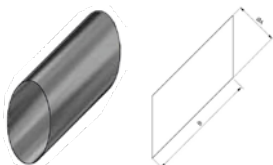

45° Wall Sleeve

Must be used where the chimney penetrates the wall at 45° through an external wall and thus providing a continuous uninterrupted run through the wall. Provides 50 mm clearance as standard.

Ø	125	150	175	200
A	220	255	280	305
B	570	570	570	570
Old Code	EXWS13	EXWS15	EXWS18	EXWS20
SAP Code	165623	165625	165627	165629
SAP Code Painted	165624	165626	165628	165630

Flashings

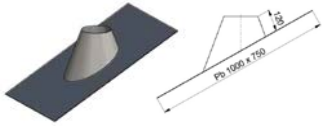

Lead Flashing Skirt 20° - 45°

These products are used externally when the installation passes through a roof structure to provide a weatherproof seal to the surrounding weathered surface.

Ø	125	150	175	200
Old Code	EXLF13	EXLF15	EXLF18	EXLF20
SAP Code	165441	165443	165445	165446
SAP Code Painted	165442	165444	165446	165448

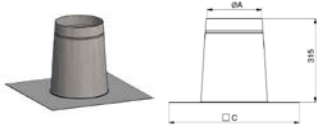

Flashing 0°

These products are used externally when the installation passes through a roof structure to provide a weatherproof seal to the surrounding weathered surface.

Ø	125	150	175	200
A	190	210	240	260
C	470	490	520	540
Old Code	EXFF13	EXFF15	EXFF18	EXFF20
SAP Code	165391	165393	165395	165396
SAP Code Painted	165392	165394		

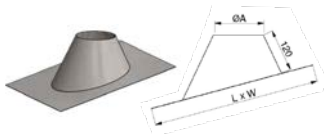

Flashing Steel Skirt 5° - 30°

These products are used externally when the installation passes through a roof structure to provide a weatherproof seal to the surrounding weathered surface.

Ø	125	150	175	200
A	190	210	240	360
LxW	550x530	575x550	610x580	630x600
Old Code	EXSF13	EXSF15	EXSF18	EXSF20
SAP Code	165553	165555	165557	165558
SAP Code Painted	165554	165556		



Storm Collar

Used to weather the top of the flashing.

Ø	125	150	175	200
Old Code	EXSC13	EXSC15	EXSC18	EXSC20
SAP Code	165545	165547	165549	165551
SAP Code Painted	165546	165548	165550	165552

Terminals



Top Stub

Top stubs are fitted to the end of the flue pipe and secured using the Twist lock system to provide complete protection for the installation. These open terminals are provided with 20 mm square anti-bird mesh.

Ø	125	150	175	200
Old Code	EXTS13	EXTS15	EXTS18	EXTS20
SAP Code	165607	165609	165611	165613
SAP Code Painted	165608	165610	165612	165614



Storm Cowl

Storm cowls are fitted to the end of the flue pipe and secured using the Twist lock system to provide complete protection for the installation. These Storm Cowls are Anti-splash and Anti-down-draught Terminals.

Ø	125	150	175	200
A	285	330	400	440
L	145	165	200	220
Old Code	EXSTCL13	EXSTCL15	EXSTCL18	EXSTCL20
SAP Code	165575	165577	165579	165581
SAP Code Painted	165576	165578	165580	165582

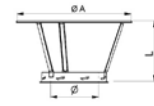

Rain Cap

Rain caps are fitted to the end of the flue pipe and secured using the Twist lock system to provide complete protection for the installation.

Ø	125	150	175	200
A	300	350	400	450
L	165	185	218	240
Old Code	EXRC13	EXRC15	EXRC18	EXRC20
SAP Code	165521	165523	165525	165527
SAP Code Painted	165522	524	165526	165528



Schiedel Metaloterm
Schiedel Chimney Systems
Crowther Estate, Washington
Tyne & Wear NE38 0AQ
Tel. +44 (0)191 416 1150

info.uk@metaloterm.com
metaloterm.com

A **stañdard**
INDUSTRIES COMPANY